

Cat.5E / Cat.6 / Multi-Function Surface Mounted Box

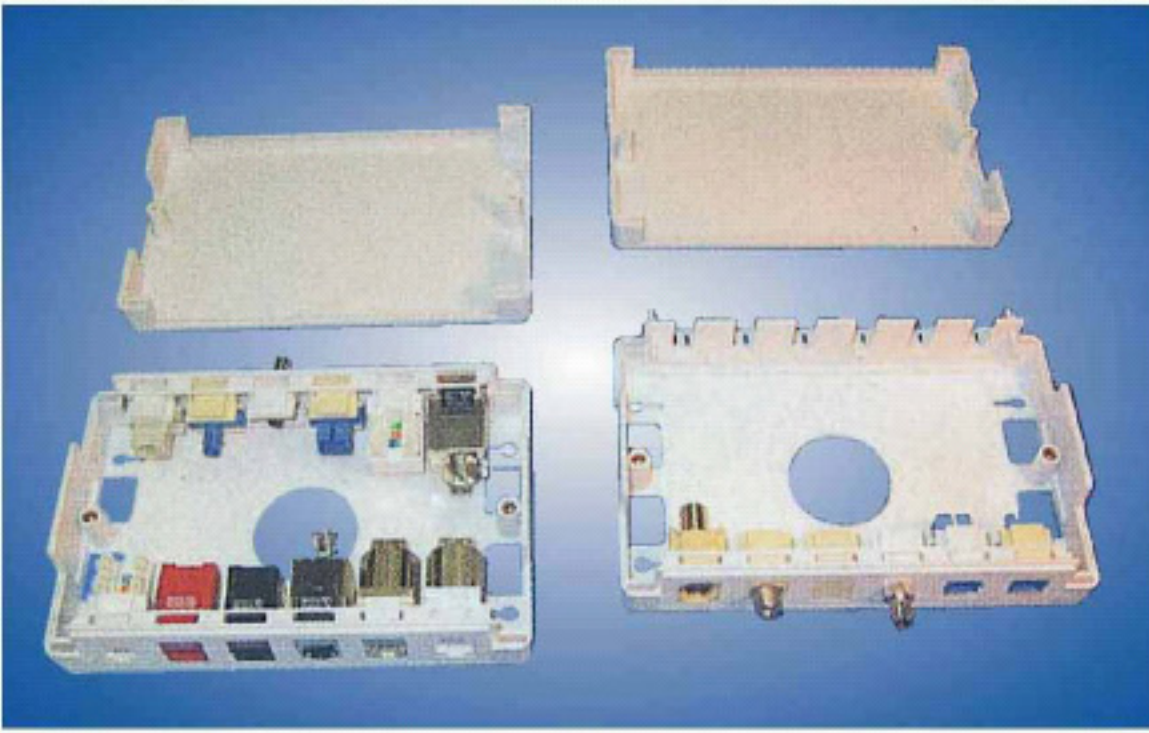

6 & 12 ports surface mounted box is ideal for easy installation of keystone jacks, fiber adaptor, F, BNC modular insert (sold separately) into the front panel of the base.

Brackets are provided on two sides of base, along with an opening in the base for cable entry when required to install 12 port box. The cable guide for cable through required only for 6 port box installation.

Full Shielded Type



Half Shielded Type

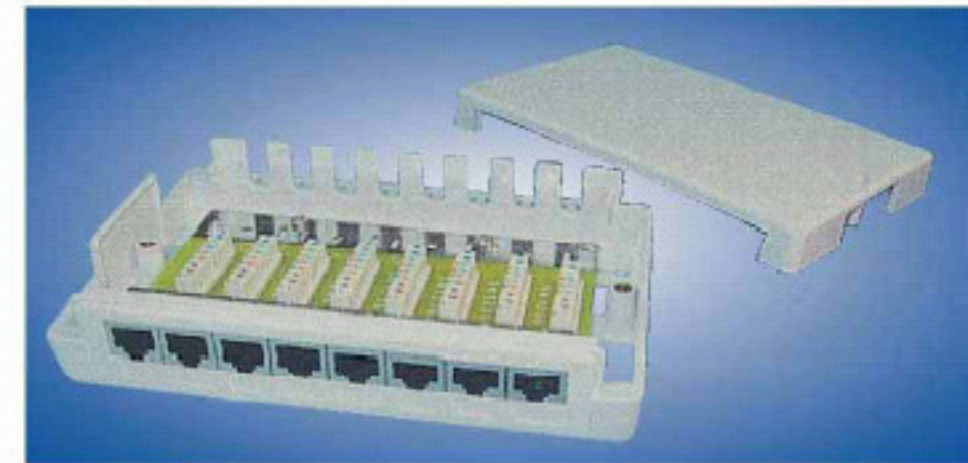

Unshielded Type

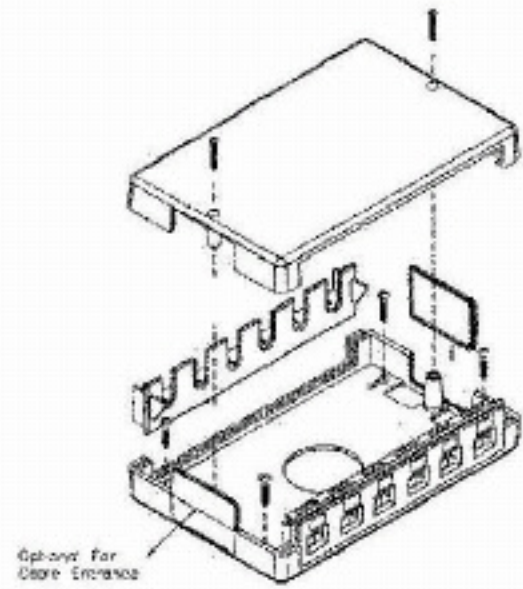
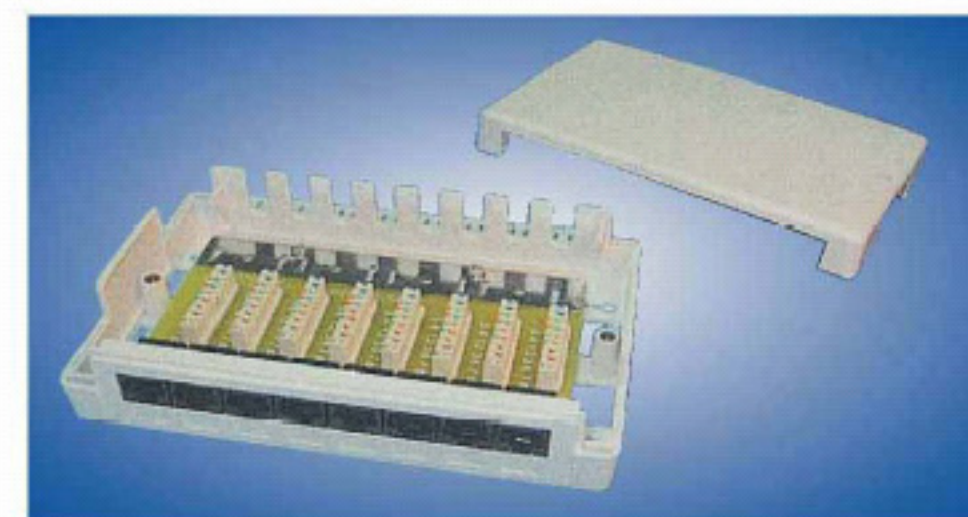

Optional for Cable Entrance

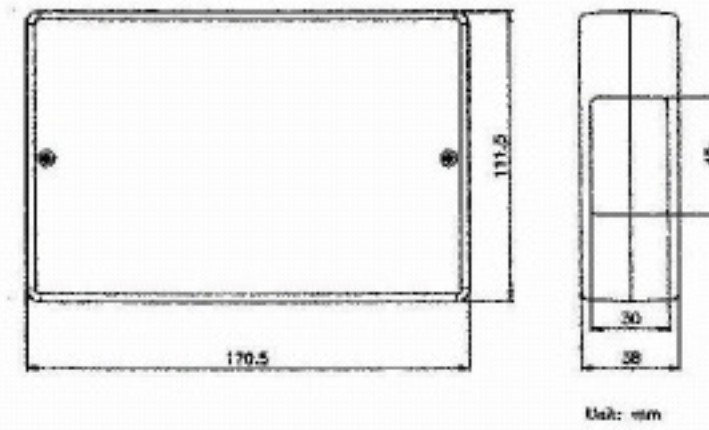

Unit: mm

Surface Mounted Box for Keystone Jack Series Only

(Consist of box x 1, front panel x 2, cable guide x 1)

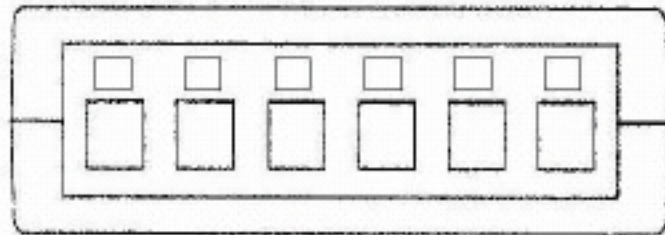

ASM12-KJ

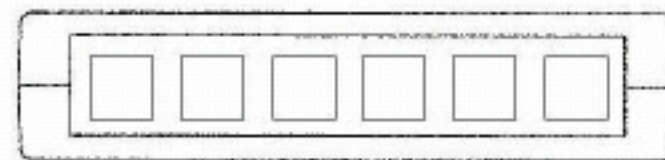

ASM12-KX

Surface Mounted Box for Keystone Jack and Modular Insert of BNC, F, & Fiber Adaptor

(Consist of box x 1, front panel x 2, cable guide x 1)

Modular Insert



AMU5-B

AMU5-BNC

AMU5-F

AMU5-XX01

AMU5-CXX07

AMU5-CXX10

AMU5-CXX11

AMU5-CXX13

AMU5-CXX16

Cat.5E / Cat.6 Inline Couplers

Adapter Type: RJ45 extension coupler

Keystone Type: RJ45 keystone coupler for easy snap-in and release.

Block Type: to connect two twisted pair cables

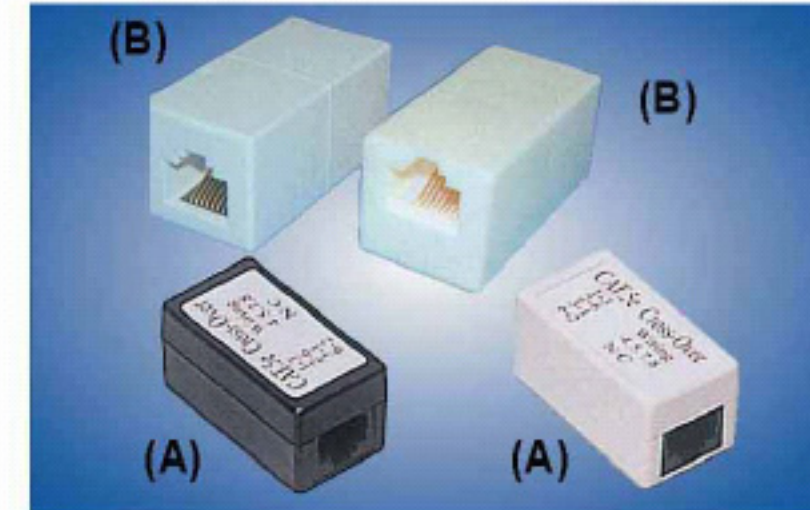
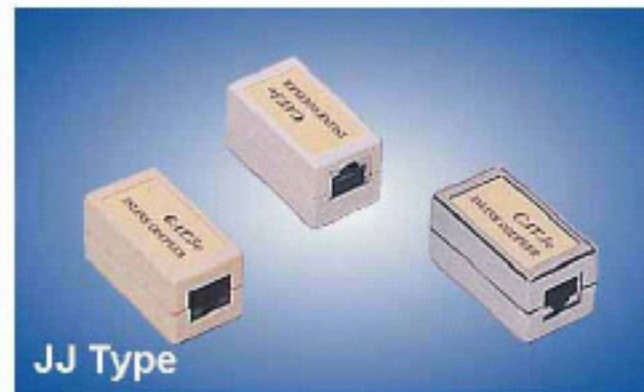

The junction box meets EIA/TIA-568-B.2 specifications. Connects 2 cabling system with IDC terminations



Spring Latch, for panel mounted.

